

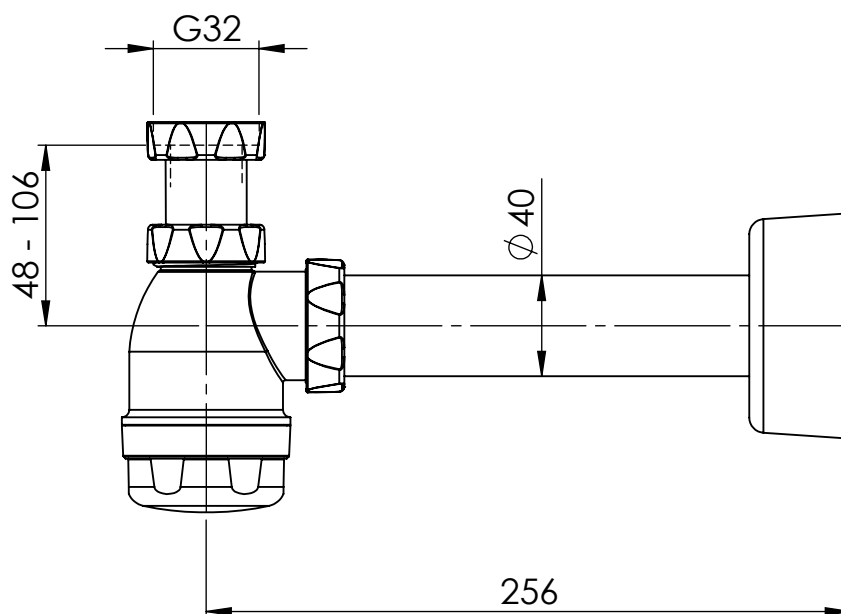

This document must not be copied without our written permission, and the contents thereof must not be imported to a third party nor be used for any unauthorized purpose. Contravention will be prosecuted. Purus AB



Den här handling får ej utan vårt medgivande kopieras. Den får ej heller delgivas annan eller ejlast obehörigen användas. Överträdelse härav beivras med stöd av gällande lag. Purus AB

Annotation		A4		This drawing replace		Replaced by		Date	
 Purus AB Södra Dragongatan 15 SE-271 39 YSTAD, SWEDEN Ph. +46 104144900 Fax +46 104144996 www.purus.se		Scale	Page	General tolerance. ISO 2768-1	Weight (gram)	Volume (cm3)	Approved by	Date	
		1:3	1(1)					SwS 2018-08-27	
Material				Surface treatment			Designer	Created date	
Name				Article no			Edition		
Vattenlåssats vägg 40 vit				8075558_måttskiss					